

ASSEMBLY INSTRUCTION

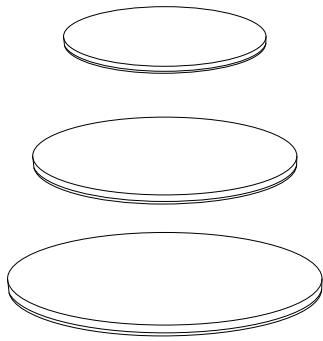

x03

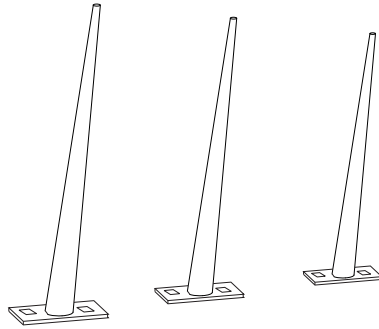

x09



x18



x18

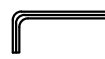

x1

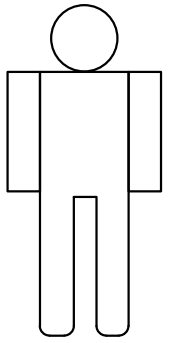

x2

STEP-01

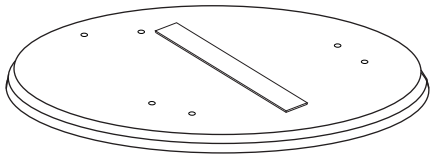

STEP-02

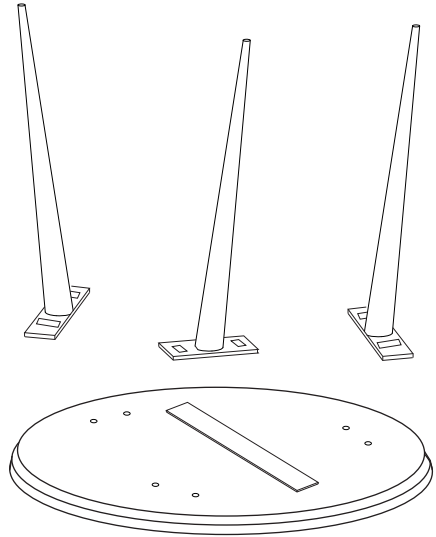

STEP-03

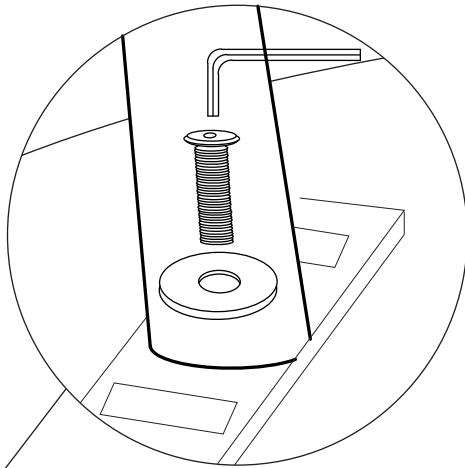

STEP-04

